

## H60 Linear lighting system

H60 linear light system looks simple but unique. It uses a combination of lines and materials to express a simple aesthetic feeling and is a beautiful landscape both in the home space and commercial space.

Inspiration



# "0" LIGHT LEAKAGE

The full edge-covered design avoids light leakage. So there is no any light leakage at the connection point, end cap, corner edge



Inspiration



## DIE-CASTING ALUMINUM END CAP

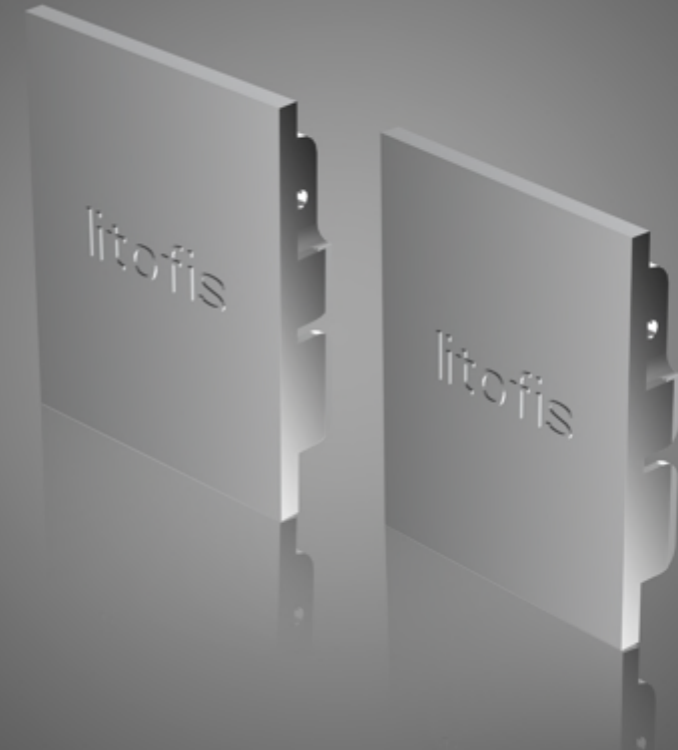

# CUSTOMIZE YOUR LOGO ON IT!



Micro-prismatic diffuser



Opal diffuser

# FLEXIBLE DIFFUSER ,25M/ROLL

## MORE THAN PERFECT!



Inspiration



**MAGNETIC  
TOP COVER**

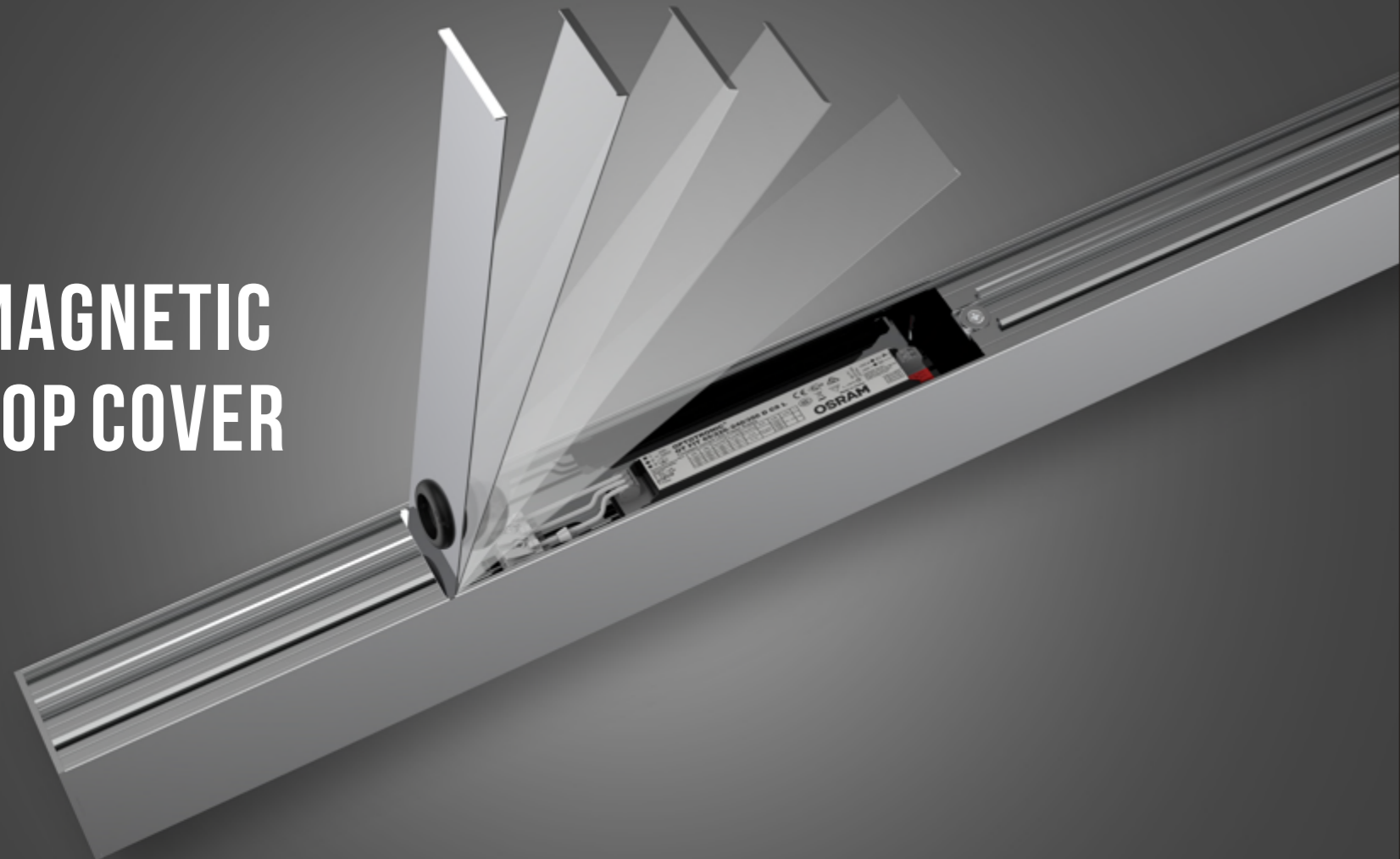

**EASY TO INSTALL AND MAINTAIN**

Inspiration

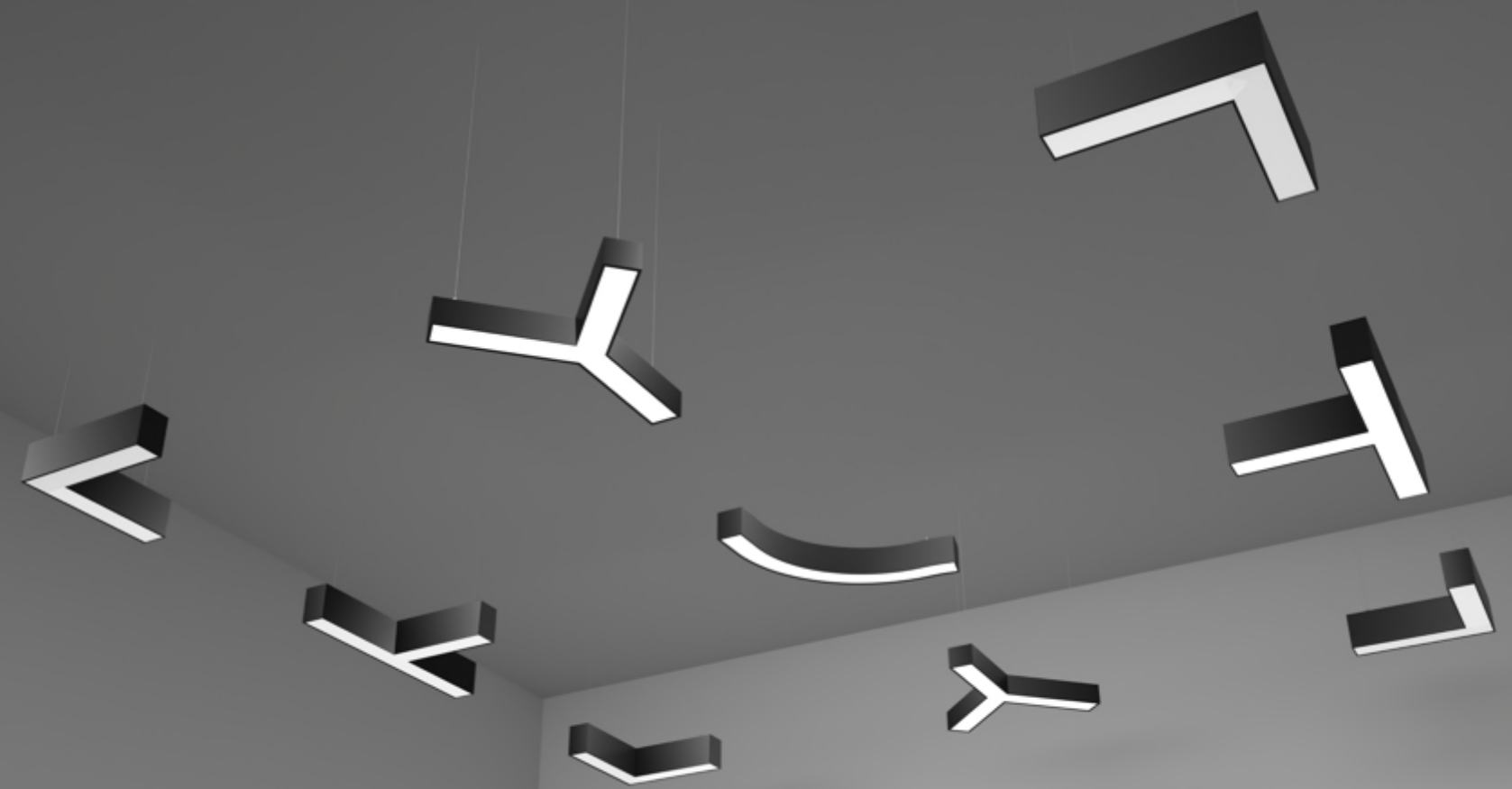

**FULL RANGE CORNERS  
SHAPE IT AS YOU WANT**

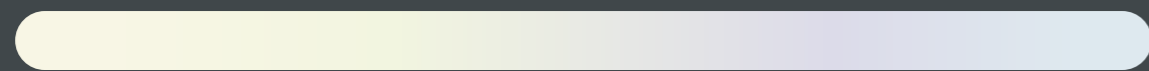

3000K

4000K

5700K

# UNLIMITED CONTROL

### Full range installation ways

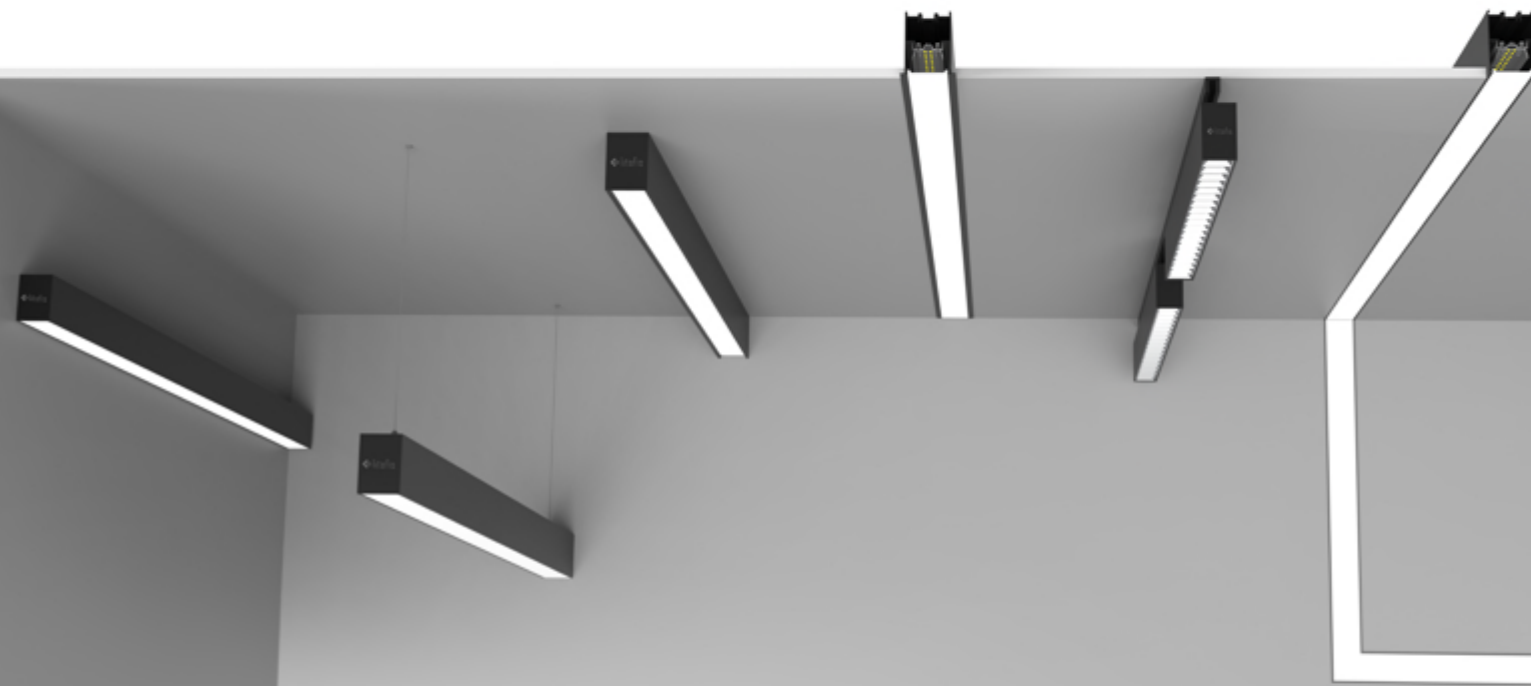

Wall mounted



Suspended

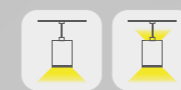

Surface mounted



Track mounted



### Powerful System Ability

The full edge-covered design avoids light leakage. No visible screws end caps, and no tools are needed to install and uninstall.

The H60 system allows for unique angles and designs to be created with ease, limited only by your imagination.

H60 achieves seamless lighting around corners, angles, and bends with the complete light leakage prevention design using Litofis's clever end caps and fast connector.

Wago fast connectors make assembly fast and easy in under 10 seconds.

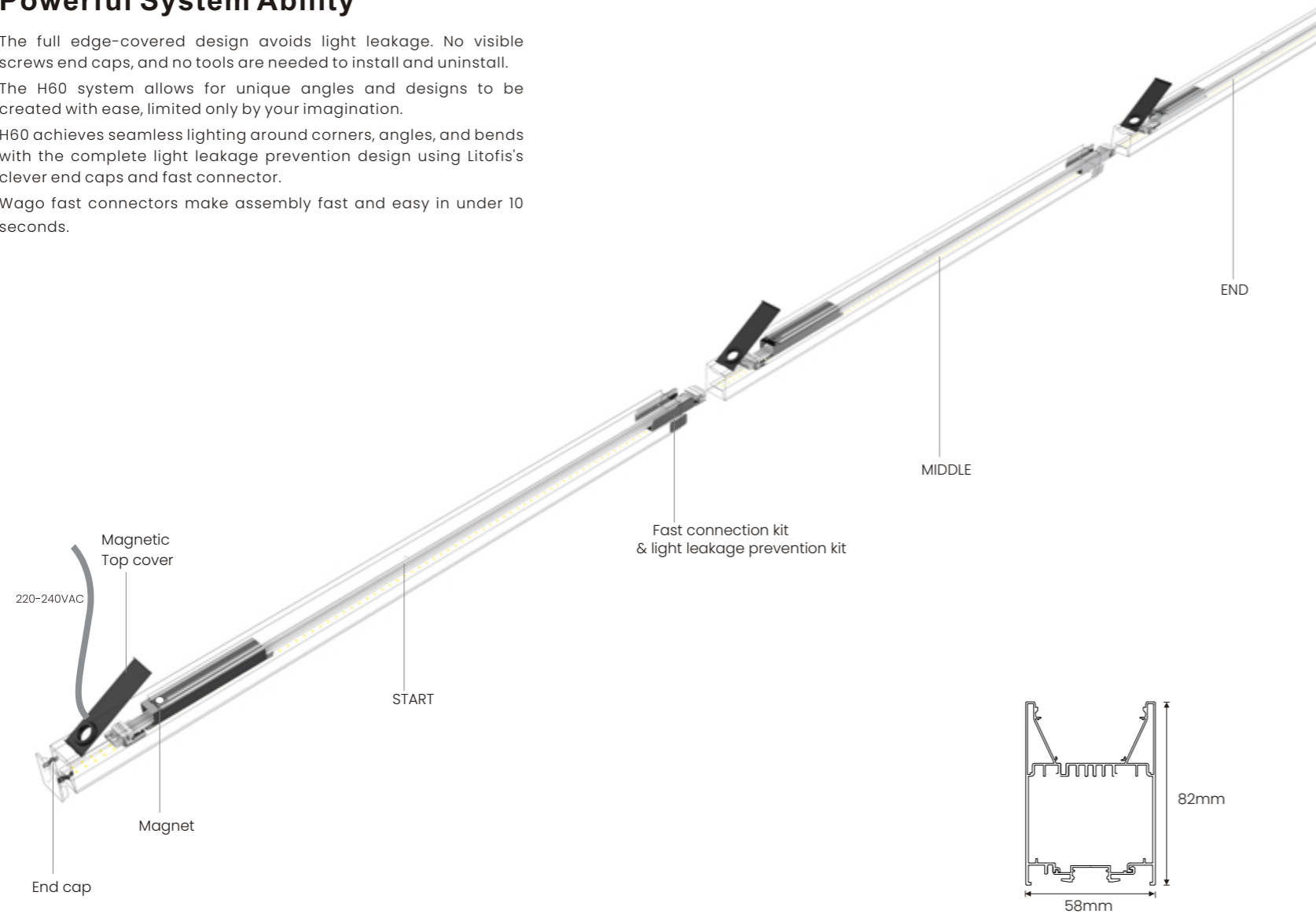

### Explosion diagram and optional accessories

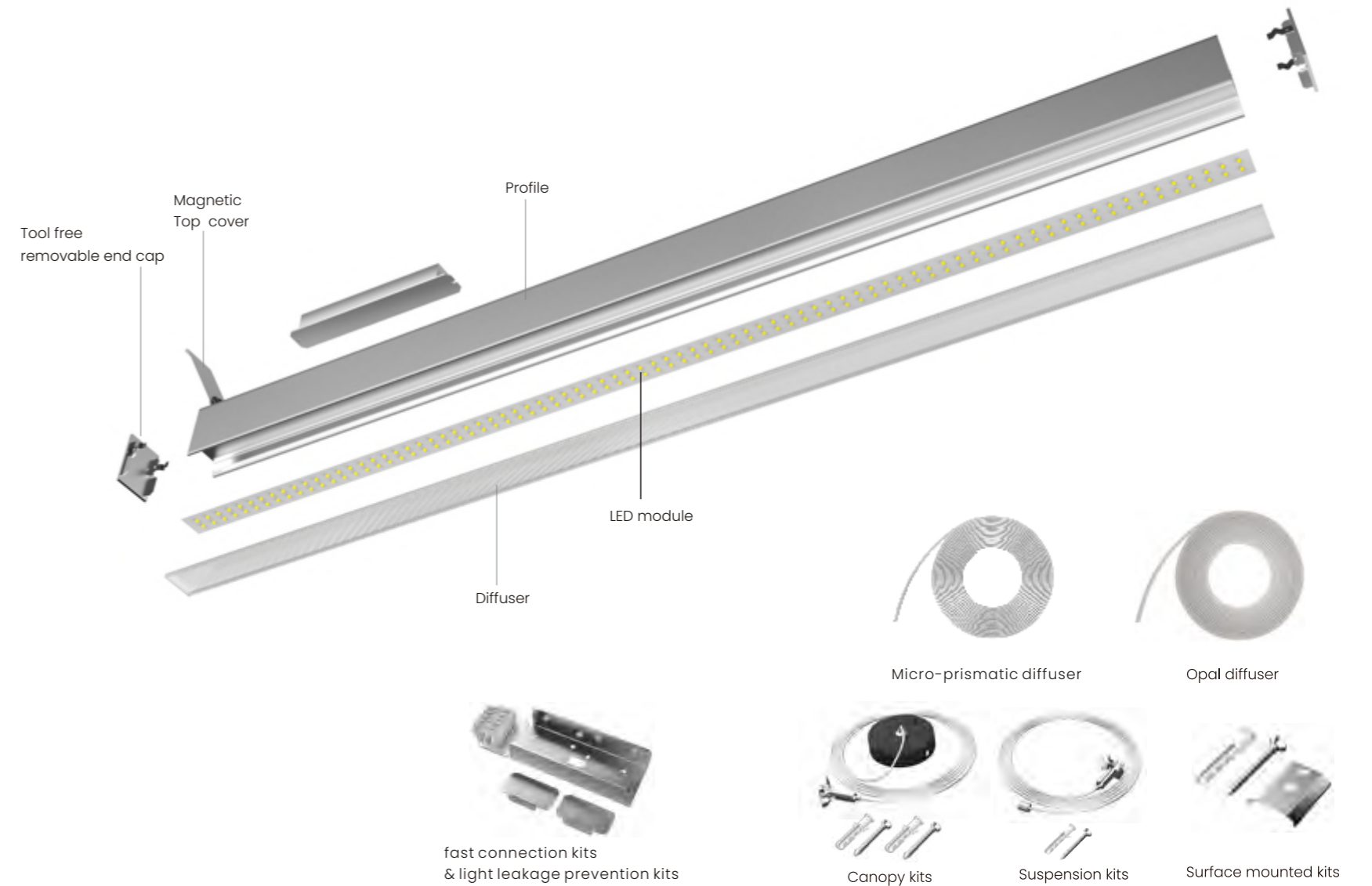

## Wide Rang Options

H60 is a minimalistic linear luminaire suitable for surface mounted, wall mounted, track mounted, direction suspended, direction&indirection suspended.

### Mounting



### Color



### Optics

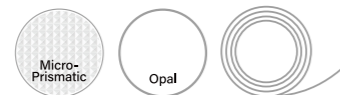

### Shapes

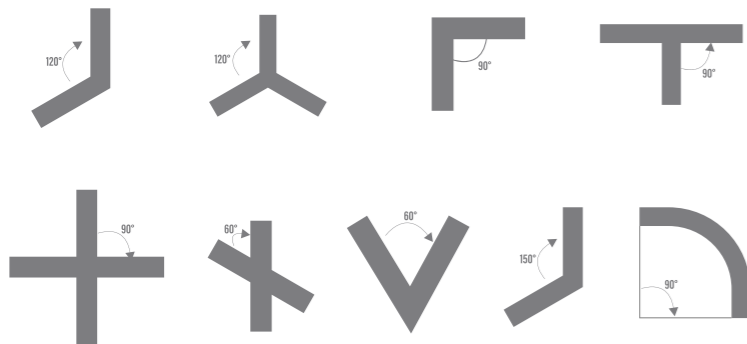

### Approval



### Length



### Link



### Control



### Light Distribution

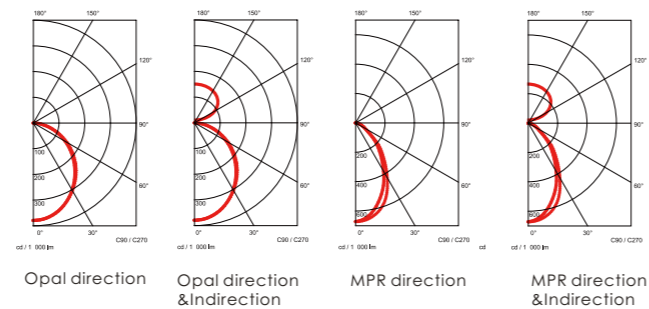

## Order code

H60 X-XXXX-RXXX-XXX-XXX-XX-X-XXXW

#### Mounting Way

S=Suspension  
C=Surface mounted  
W=Wall mounted  
P=Track mounted

Length: 0565-2455

#### Corner shape:

90° L corner = L090  
120° L corner = L120  
150° L corner = L150  
60° L corner = L060  
120° Y corner = Y120  
90° T corner = T090  
90° Cross = C090  
60° Cross = C060  
Round Edge Corner=R090

#### CRI

RA80=8  
RA90=9

#### Light color

3000K=30  
4000K=40  
5700K=57

#### Housing color

White = WH  
Black = BH  
Silver = SH

Single light = D  
Linkable version:  
Start = S  
Middle = M  
End = E

#### Light direction

Direction only = DO  
Direction&indirection = DI  
Indirection only = IO

#### Control type

DALI dimmable = DAL  
Non-dimmable=NON  
DALI DT8 = DT8

#### Power

eg:  
18W=180  
40.5W=405

#### Diffuser

Opal = O  
Micro prismatic = M

Eg.

H60S-2245R840-BHO-NON-DO-D-720W

means :

H60 Suspended, 2245mm long, RA80, 4000K, black housing, opal diffuser, non dimmable, direction, single light, 72W





**H60**  
System



**litofis**

**H60**  
System



**litofis**

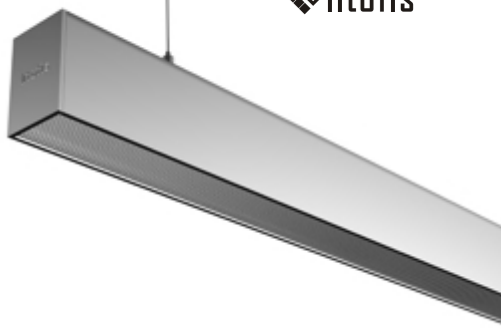
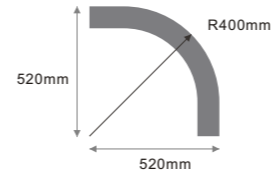
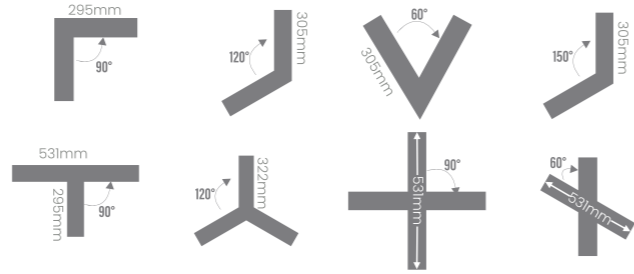
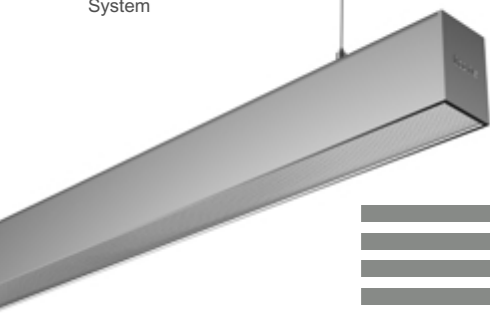

Item	Length	Section size	Link	Voltage	Power	System Efficacy	Color	Optics	LEDs	CCT	CRI	Color consistency	UGR	Driver	Control
H60-2245	2245mm	W58xH82mm	single light / linkable	220-240VAC	41-72W	115lm/w	White/Black/Silver grey	Opal/Micro-prismatic	Osram	3000K/4000K/5700K or TW 3000K-5700K	CRI>80 / CRI>90	MacAdam step 3	UGR<22/UGR<19	Osram	ON-OFF/DALI 2 /DALI DT8(tunable white)
H60-2315	2315mm	W58xH82mm	single light / linkable	220-240VAC	42.5-53W	115lm/w	White/Black/Silver grey	Opal/Micro-prismatic	Osram	3000K/4000K/5700K or TW 3000K-5700K	CRI>80 / CRI>90	MacAdam step 3	UGR<22/UGR<19	Osram	ON-OFF/DALI 2 /DALI DT8(tunable white)
H60-2385	2385mm	W58xH82mm	single light / linkable	220-240VAC	44-55W	115lm/w	White/Black/Silver grey	Opal/Micro-prismatic	Osram	3000K/4000K/5700K or TW 3000K-5700K	CRI>80 / CRI>90	MacAdam step 3	UGR<22/UGR<19	Osram	ON-OFF/DALI 2 /DALI DT8(tunable white)
H60-2455	2455mm	W58xH82mm	single light / linkable	220-240VAC	45.5-57W	115lm/w	White/Black/Silver grey	Opal/Micro-prismatic	Osram	3000K/4000K/5700K or TW 3000K-5700K	CRI>80 / CRI>90	MacAdam step 3	UGR<22/UGR<19	Osram	ON-OFF/DALI 2 /DALI DT8(tunable white)

Item	Length	Section size	Link	Voltage	Power	System Efficacy	Color	Optics	LEDs	CCT	CRI	Color consistency	UGR	Driver	Control
H60-R090	520x520mm	W58xH82mm	single light / linkable	220-240VAC	20.5-36W	115lm/w	White/Black/Silver grey	Opal/Micro-prismatic	Osram	3000K/4000K/5700K or TW 3000K-5700K	CRI>80 / CRI>90	MacAdam step 3	UGR<22/UGR<19	Osram	ON-OFF/DALI 2 /DALI DT8(tunable white)

### Specification of different length and current

length (mm)	@350mA		@300mA		@250mA		@200mA	
	Power(W)	lumen	Power(W)	lumen	Power(W)	lumen	Power(W)	lumen
565	18.0	2070	15.4	1821	12.9	1543	10.3	1255
635	20.3	2329	17.4	2048	14.5	1736	11.6	1412
705	22.5	2588	19.3	2276	16.1	1929	12.9	1569
775	24.8	2846	21.2	2503	17.7	2121	14.1	1725
845	27.0	3105	23.1	2731	19.3	2314	15.4	1882
915	29.3	3364	25.1	2958	20.9	2507	16.7	2039
985	31.5	3623	27.0	3186	22.5	2700	18.0	2196
1055	33.8	3881	28.9	3414	24.1	2893	19.3	2353
1125	36.0	4140	30.9	3641	25.7	3086	20.6	2510
1195	38.3	4399	32.8	3869	27.3	3279	21.9	2667
1265	40.5	4658	34.7	4096	28.9	3471	23.1	2823
1335	42.8	4916	36.6	4324	30.5	3664	24.4	2980
1405	45.0	5175	38.6	4551	32.1	3857	25.7	3137
1475	47.3	5434	40.5	4779	33.8	4050	27.0	3294
1545	49.5	5693	42.4	5007	35.4	4243	28.3	3451
1615	51.8	5951	44.4	5234	37.0	4436	29.6	3608
1685	54.0	6210	46.3	5462	38.6	4629	30.9	3765
1755	56.3	6469	48.2	5689	40.2	4821	32.1	3921
1825	58.5	6728	50.1	5917	41.8	5014	33.4	4078
1895	60.8	6986	52.1	6144	43.4	5207	34.7	4235
1965	63.0	7245	54.0	6372	45.0	5400	36.0	4392
2035	65.3	7504	55.9	6600	46.6	5593	37.3	4549
2105	67.5	7763	57.9	6827	48.2	5786	38.6	4706
2175	69.8	8021	59.8	7055	49.8	5979	39.9	4863
2245	72.0	8280	61.7	7282	51.4	6171	41.1	5019
2315	N/A	N/A	N/A	N/A	53.0	6364	42.4	5176
2385	N/A	N/A	N/A	N/A	54.7	6561	43.7	5333
2455	N/A	N/A	N/A	N/A	57.0	6844	45.6	5567

\*Options:  
-Presence and light sensors  
-Emergency: 1h or 3h  
-2700k or other CCT  
-100-277VAC

\*The length mentioned above means the profile length without the end cap, for general version, each end cap is 3mm long; There may be differences in the dimensions for dimmable and non-dimmable corners, the dimensions in the parameter table are for the non-dimmable version

\*Lumen is based on completed linear light. (modules are in the profile, and covered by diffuser)

\*There might be 5% tolerance of Power, due to the Vr value of Osram LEDs changing while the current changing.

H60

H60



H60  
System

litofis

H60  
System

litofis

H60

H60